



HYDRAULIC ALLROUNDERS

Uniquely versatile injection
moulding machines

ARBURG

EXEMPLARY

The ALLROUNDER philosophy:
modularity and flexibility
for your ideal solution.

With the ALLROUNDER principle, differential piston system, and ScrewPilot, we have been setting standards in hydraulic injection molding technology since 1961. You can choose from a range of injection molding machines that have been consistently designed to meet your daily production needs. From the standardized GOLDEN EDITION general-purpose machine series to the highly adaptable, modular ALLROUNDER S: ARBURG's hydraulic machines ensure high quality and production at competitive unit costs in numerous injection molding plants around the world. And this has been the case for many generations.

WIR SIND DA.



Modular design: process-optimised solutions for greater production efficiency.

AT A GLANCE

// Reliable, proven injection moulding technology “Made by ARBURG - Made in Germany”: This is what our hydraulic machines stand for. With the ALLROUNDER principle, differential piston system and position-regulated screw, we have been setting benchmarks since 1961. They range from the low-cost general purpose GOLDEN EDITION model to the flexible, adaptable ALLROUNDER S. Our modular design offers you process-optimised solutions with low operating costs and the greatest possible variety of applications. You simply specify your requirements and we configure a suitable ALLROUNDER especially for you. //

Highlights

- Versatile hydraulics with multiple technology levels
- Efficient differential piston system
- Reproducible injection with aXw Control ScrewPilot
- ALLROUNDER and VARIO principles

Diverse applications

Our machine concept is extremely flexible and can be precisely adapted for operation in conjunction with all familiar injection moulding processes. This is ensured by numerous equipment and configuration options. For example, the ALLROUNDER S can

- use swivelling clamping units to overmould inserts (ALLROUNDER principle).
- work with an interchangeable injection unit in the mould parting line.
- fill the mould in a linear action using a horizontally free-sliding injection unit (VARIO principle).

Individuality

The power of the drive technology can be individually adapted. Multiple hydraulic variants and electrical configuration levels allow you to achieve greater energy efficiency, higher precision and speed - just as your application demands.

Cost efficiency

The GOLDEN EDITION is our general purpose hydraulic model. The recipe for success: The use of proven, uncompromising high-end technology, standardised at an unbeatable price. Two-circuit pump technology is provided as standard for example.

Reproducibility

Regulated injection ensures the customary high part quality. The unique ScrewPilot can therefore be used to achieve dynamic and reproducible injection that is on a par with electric machines.

Reliability

Optimum availability and a long service life are synonymous with the ARBURG name. Examples include energy-saving oil displacement via the differential piston system of the clamping unit, or the scratch-proof powder enamel coating of the machine components.

Adaptable drive technology:
multiple hydraulic variants and
electric expansion stages.

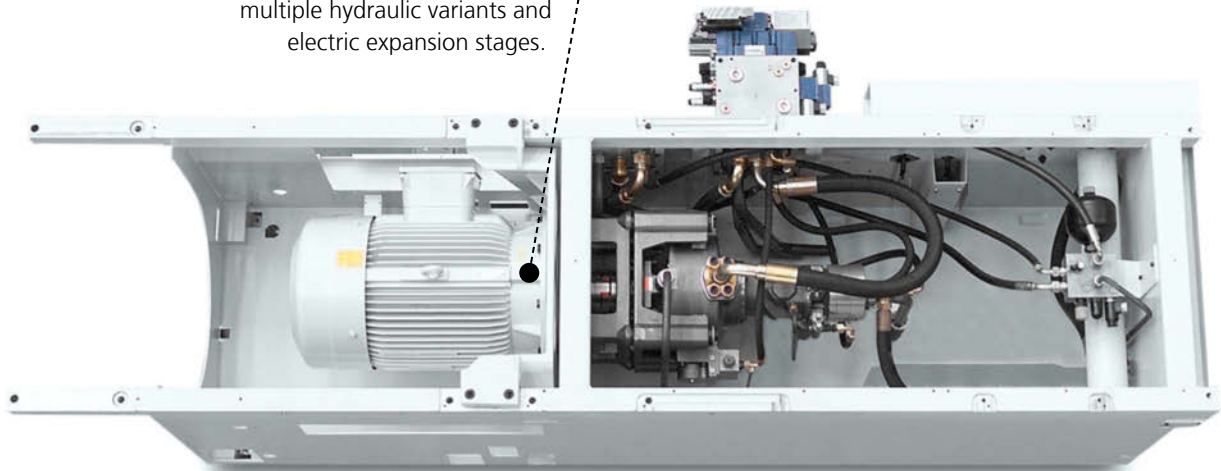

GOLDEN EDITION

Distance between tie bars: **270 - 570 mm**

Clamping forces: **400 – 2,000 kN**

Injection units: **70 - 800**

ALLROUNDER S

Distance between tie bars: **170 - 920 mm**

Clamping forces: **125 – 5,000 kN**

Injection units: **30 - 4600**

"Made by ARBURG - Made in Germany":
We consistently implement
this quality standard.

ARBURG
ALLROUNDER

GOLDEN
EDITION

LEADING TECHNOLOGY – UNBEATABLE PRICE

// Why should you place your trust in our hydraulic ALLROUNDERS?
Because you then rely on the best system you can get. This also applies
to our GOLDEN EDITION general purpose model, which is tailored specifi-
cally to your requirements. Our "golden" measure: consistently standard-
ised injection moulding technology at an unbeatable price. Ideal for
consistent cost-effective production of your quality parts. //

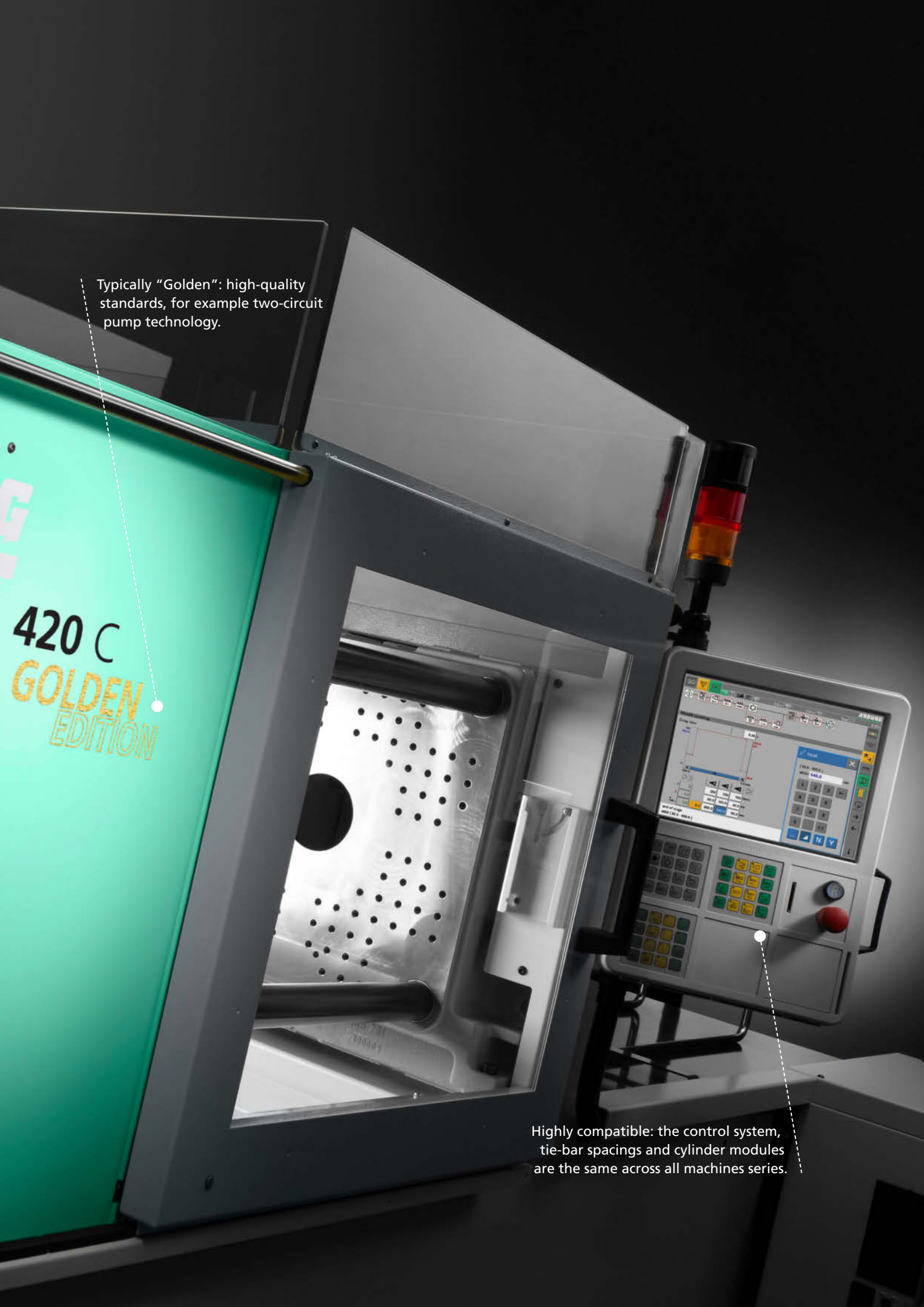

Typically "Golden": high-quality standards, for example two-circuit pump technology.

420 C
GOLDEN
EDITION

Highly compatible: the control system, tie-bar spacings and cylinder modules are the same across all machines series.

ALLROUNDER S: MODULARITY MEANS FLEXIBILITY

// “Modularity is key!” – this principle is put into practice in our ALLROUNDER S machines. This results in unrivalled flexibility. You want to achieve energy-efficient implementation of standard tasks? You want to use sophisticated tools with simultaneous processes? You need to produce high-speed items with high filling dynamics? No problem: we have the right hydraulic drive for all your requirements. This enables you to precisely coordinate machine and application with individual customisation. //

Hydraulic technology stages

T1: Single-circuit pump technology for particularly energy-saving operation with servo hydraulics (ASH).

- Exclusively serial movements
- Fixed clamping and nozzle contact force

T2: Two-circuit pump technology for optimized sequences/cycles and more process engineering options. Alternatively, productivity package with water-cooled, speed-regulated motor.

- Shorter dry cycle times and higher injection speeds
- Simultaneous ejector, nozzle or core-pull movements
- Controlled clamping and nozzle contact force in several stages

Accumulator: hydraulic accumulator technology for thin-wall applications and the highest demands in terms of performance and process capability.

- Further reduced dry cycle times and maximum injection speeds
- Simultaneous and very precise movements – all axes are regulated independently and the aXw Control ScrewPilot for highly reproducible injection is a standard feature.

From small to large:
ALLROUNDER S machines
cover a wide range of sizes.

ARBURG

ALLROUNDER 920 S



ARBURG

ALLROUNDER 170 S

DRIVE TECHNOLOGY: VERSATILE

// Comprehensive reliability and performance through continuous model refinement: our sophisticated, modular drive technology is the perfect basis for this. From single-circuit pump technology for simple processes to two-circuit pump technology and hydraulic accumulator technology for short cycle times and high filling dynamics. From rotational-speed regulated pump motors to electric expansion stages for higher energy efficiency and precision. Our hydraulic ALLROUNDER machines leave nothing to be desired. //

Adaptable: advantages of hydraulic variants and electric expansion stages.

	CYCLE TIME	ENERGY
 T1 Single-circuit pump technology (ASH)		++
T2 Two-circuit pump technology	+	
Energy-saving system (AES)	+	+
Accumulator Hydraulic accumulator technology	++	
 Electric dosage (AED)	+	+

 Hydraulic

 Electric

+ Good

++ Very good

Precise control technology

The precise implementation of all movements forms the basis for high-quality parts production. The features of our hydraulic system include:

- Consumption-dependent, dynamic p/Q control
- Closed control circuit – irrespective of the wear to the pump
- Fast-switching valve technology
- Valves for injection and dosing close to the consumer
- Position-related ramps for precise positioning

Electric expansion stages

ARBURG electro-mechanical dosage (AED) is available as an alternative. The drive operates independently of the hydraulics and can thus be executed simultaneously with other movements. In addition to cycle-time and energy savings, this also enhances precision.

“More efficiency packages”

The hydraulic drive with water-cooled, speed-regulated pump motor offers an interesting alternative. The ARBURG servo hydraulic system (ASH) and energy saving system (AES) minimize no-load losses. This results in significant energy savings and reduced cooling requirements and noise levels. In the productivity package, AES also enables higher rotational speeds for faster cycles as required.

In the case of the ALLROUNDER S machines, the AES is also part of the advance equipment package. In addition, these machines also feature electro-mechanical dosage (AED) and the ScrewPilot for highly reproducible injection. As a result, they offer high energy efficiency, high part quality, and optimized cycle times at an attractive price.



Precise: reproducible injection through valves situated close to consumers.

AES or AED offer up to 20%
and ASH up to

50 %

**ENERGY
SAVING**



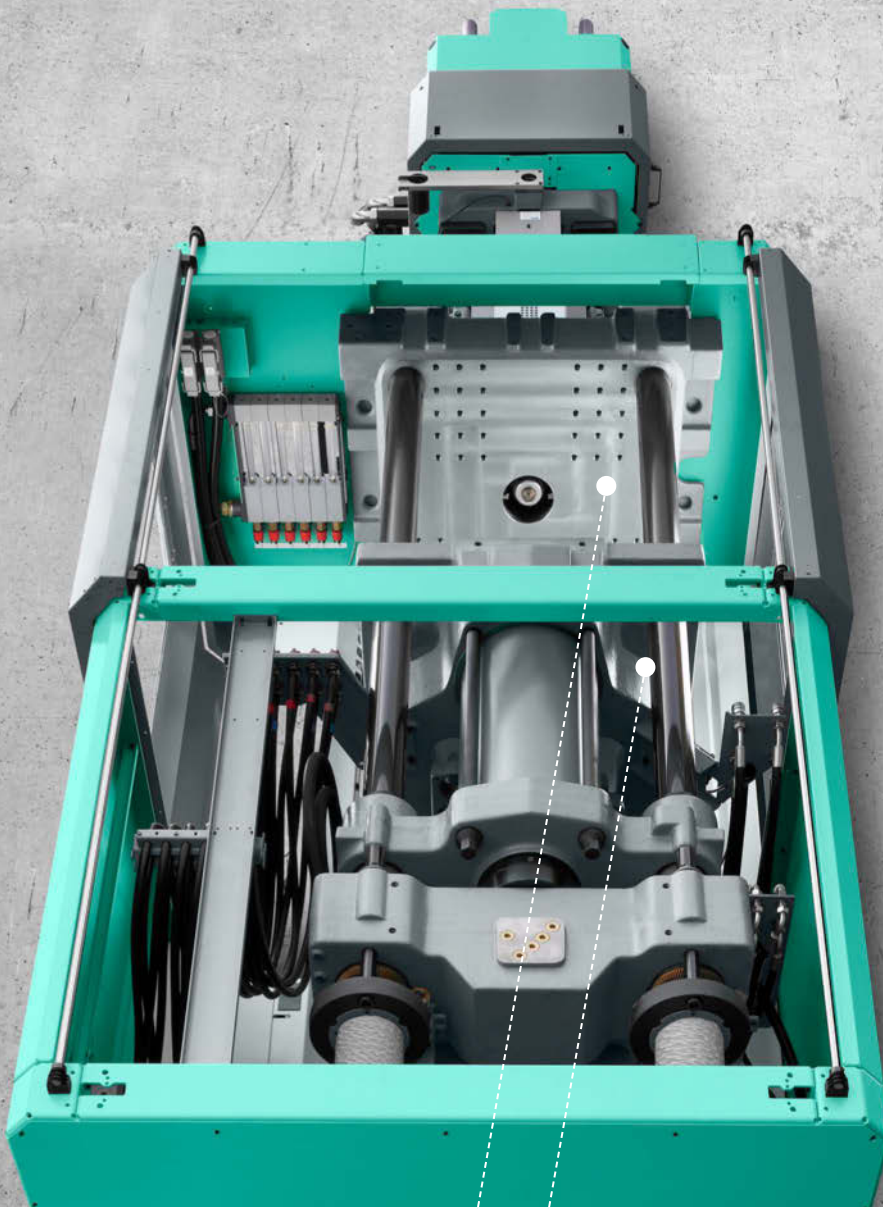

Installation area and opening stroke:
also suitable for large moulds.

Easy access: cross-series ejector
quick-connect coupling simplifies set-up.

CLAMPING UNITS: RELIABLE

// Compact design and perfect accessibility are the key features that really count for you. This makes our hydraulic ALLROUNDERS simple, reliable and convenient to work with. The more stable the design and construction of the clamping units, the more gentle they will be on your moulds. The compatibility that is standard at ARBURG means that moulds can be used on different machine series without any problem. //

Energy-efficient cylinder system

Our unique differential piston system ensures effective and energy-saving oil circulation with a lower cooling requirement. This makes fast and slow movement at high power possible. The compact design with only a small number of sealing points to the outside is also impressive.

Gentle mould use

The box-type construction of the movable mounting platen is longitudinally guided and supported as standard from size 370 onwards. Together with three-platen technology and four tie-bar guidance, this results in high parallelism and precision. The forces during movement and closure are applied evenly - even with heavy moulds. Sensitive mould protection also provides for long mould life.

Wide application range

Large range of sizes with finely graduated clamping forces, automatic mould height adjustment systems as standard from ALLROUNDER 630 S and swivelling clamping units up to 370 S: Process-optimised design in terms of application and energy requirements is therefore possible throughout.

Media connections close to the mould (optional): the increased protection towards the back of the machine provides for much free space.

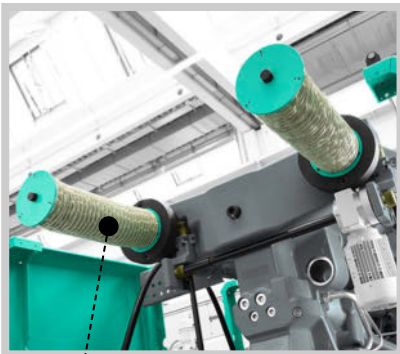

Electric mould height adjustment: the basis for high-speed, energy-saving cycles for 630-920 S machines.

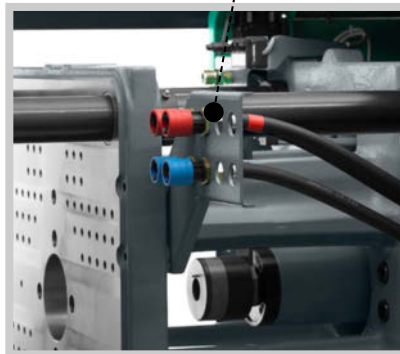

ALLROUNDER principle (optional): pivoting clamping unit offers even greater diversity in applications.



Simple conversion: central coupling of all cylinder module supply units and screw quick-connect coupling.

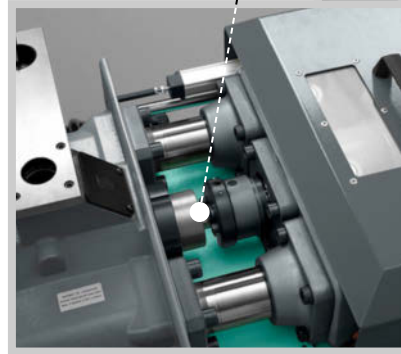

Swivelling injection unit: the screw can then be removed without dismantling the cylinder module.

INJECTION UNITS: ADAPTABLE

// Homogeneous material preparation and reproducible mold filling: The precise automatic control technology of our hydraulic system forms the basis for high-quality parts production. Features including the aXw Control ScrewPilot, ARBURG electro-mechanical dosage (AED), and hydraulic accumulator technology allow you to get even more out of your processes. Our injection units are quick to set up and clean. In a vertical set-up, injection units in sizes up to 400 can inject into the mold parting line. Finally, our VARIO principle permits horizontal linear mold filling. It doesn't get more flexible than that! //

REPRODUCIBLE
MOULD FILLING 
with our ScrewPilot – fluctuations in the shot weight can be significantly reduced

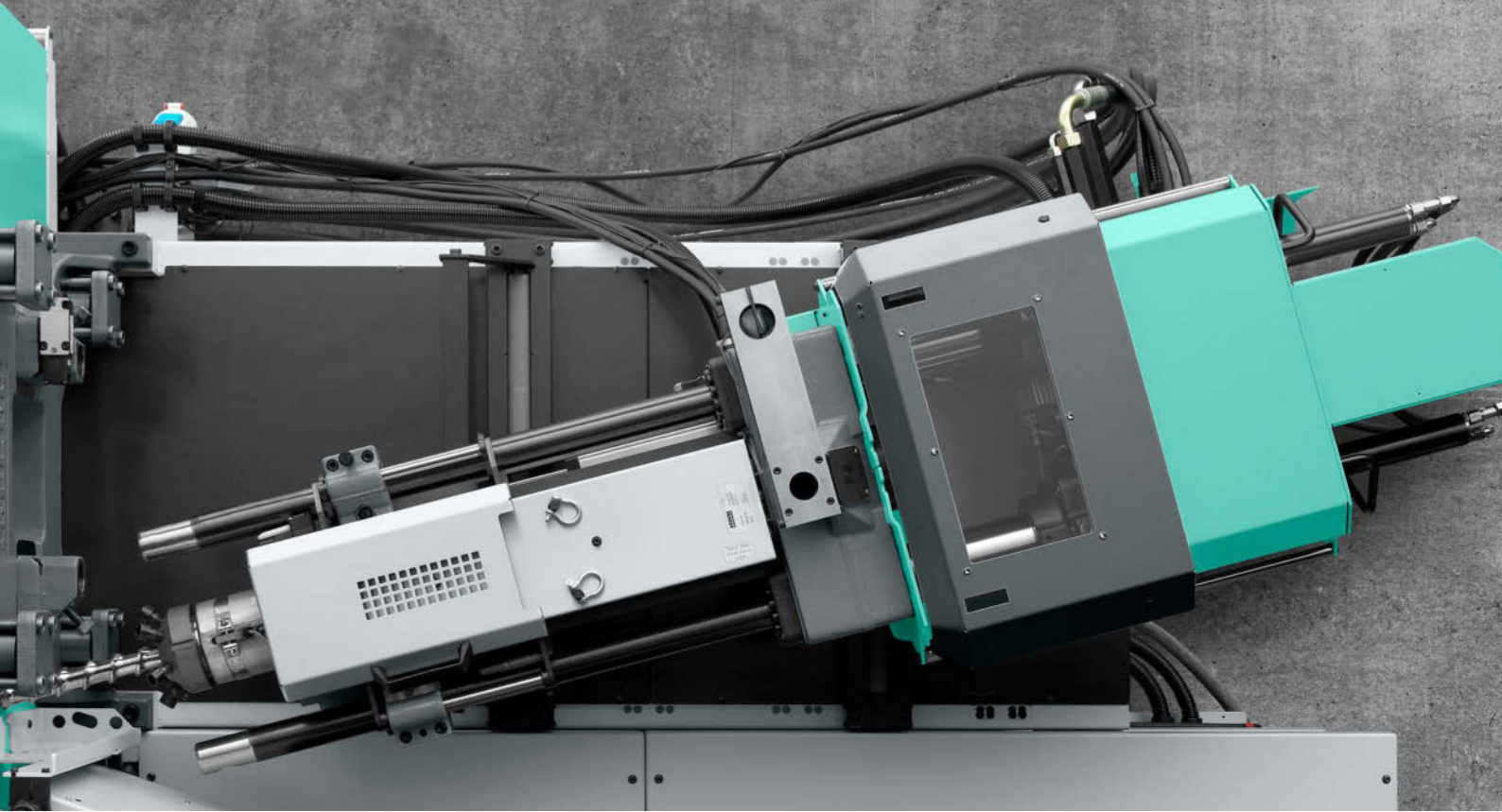

Wide variety of combinations

The cylinder modules are compatible with all series and are finely graded. Various versions ensure optimum protection against wear. In addition, screws in special geometries allow you to process all common plastics.

Controlled injection

Reproducible mold filling: Pressure and speed are regulated during injection. Our ScrewPilot enables you to take control accuracy and molded part quality to the next level. Hydraulic accumulator technology offers you even more dynamic injection molding.

Torque-free nozzle contact

Our two-tie-bar guide facilitates absolutely leak-tight nozzle contact – also ideal for both flat and extended nozzles. The build-up of the nozzle contact forces is programmable and regulated, which reduces wear on the nozzle and mould.

AED: Electric dosing system

The AED option leads to significant energy savings with increased precision. A further result: significantly reduced cycle times in some cases. Since the melt can be dosed simultaneously and cyclically, it can also be processed more gently.



CONTROL SYSTEM: SMART

// Maintaining control over the machine, mould, robotic technology and peripheral technology requires a suitably powerful central control system. This calls for smart technology that offers extensive data integration options, monitors and adaptively controls your process, and supports you in every operating situation. All the features of our SELOGICA and GESTICA control systems are designed for a fast, secure and convenient set-up and operating process. This allows you to get the best out of all your applications. //

Highlights

- SELOGICA and GESTICA – fully compatible
- Graphic sequence programming
- Direct plausibility checks
- Assistance packages and connectivity modules
- “Ready for Digitalisation”
- Central control system for complete production cells

i / Further information:
GESTICA brochure

Central management

Thanks to their unsurpassed standard operating system, the SELOGICA and GESTICA save time and costs. The simple integration of different peripheral equipment enables sequence management even for complete production cells, with only one data set. Short cycle times? Can be programmed!

Intuitive operation

The graphics-based operational philosophy can be comprehended intuitively and is always geared towards optimisation of the processes. Our unique graphical sequence programming with direct plausibility check always clearly indicates the logical position of the current programming step. Operating errors? Out of the question!

More efficient operation

Easy set-up and fast start-up. Assured part quality and excellent productivity. Controlled system status and time-saving support. Higher-level data exchange and more transparency. Our assistance packages and connectivity modules provided as standard form the basis for all these benefits. Ready for digitalisation? Of course!

The pioneering GESTICA control system builds on the comprehensive performance of the SELOGICA system. Gestures and added assistance make operation even simpler and more intuitive.



The SELOGICA control system offers a whole range of functions for specialised technology – even non-standard sequences are handled as though they were standard.

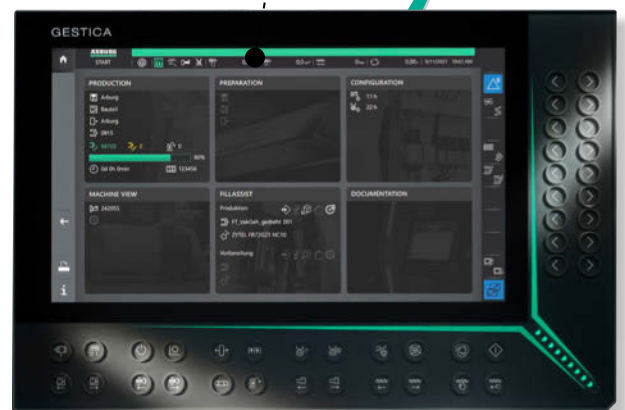

APPLICATIONS: IN PRACTICE

// From the general purpose GOLDEN EDITION model to the ALLROUNDER S tailored to your specific production requirements: when you use our hydraulic machines, you can process all known injectable material types, including ceramic and metal powder compounds, efficiently and economically - guaranteed! This enables us to provide you with exactly what you need every day: reliable machines and production cells that are capable of every injection moulding task. //

Large parts: shot weights exceeding two kilograms are achievable.



From automotive to medical:
complete turnkey systems from
a single source.

 Further information:
turnkey projects brochure



Multi-component technology: the modular ALLROUNDER S machines enable flexible configurations.

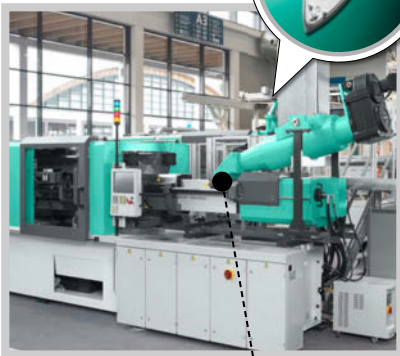

Thermoset processing: special equipment ensures high part quality.

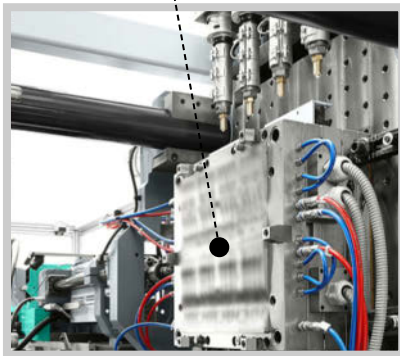

Specialised technology: equipment packages for a wide variety of applications, such as optical components.

i / Further information:
application expertise brochure



Scan this code to visit our
Media Centre: in-depth,
captivating, entertaining.

ARBURG GmbH + Co KG
Arthur-Hehl-Strasse
72290 Lossburg
Tel.: +49 7446 33-0
www.arburg.com
contact@arburg.com

WIR SIND DA.

© 2024 ARBURG GmbH + Co KG | All data and technical information have been compiled with great care. However we accept no responsibility for correctness. Individual illustrations and information may deviate from the actual delivery condition of the machine. The relevant valid operating instructions are applicable for the installation and operation of the machine.